

Motor – Driven siren MDS-2

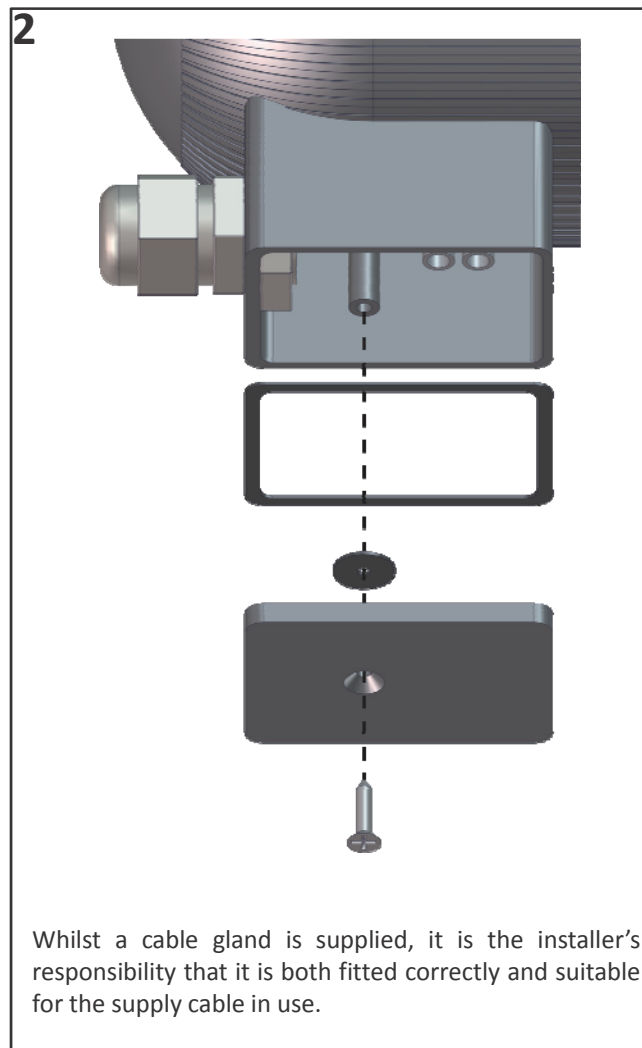

1

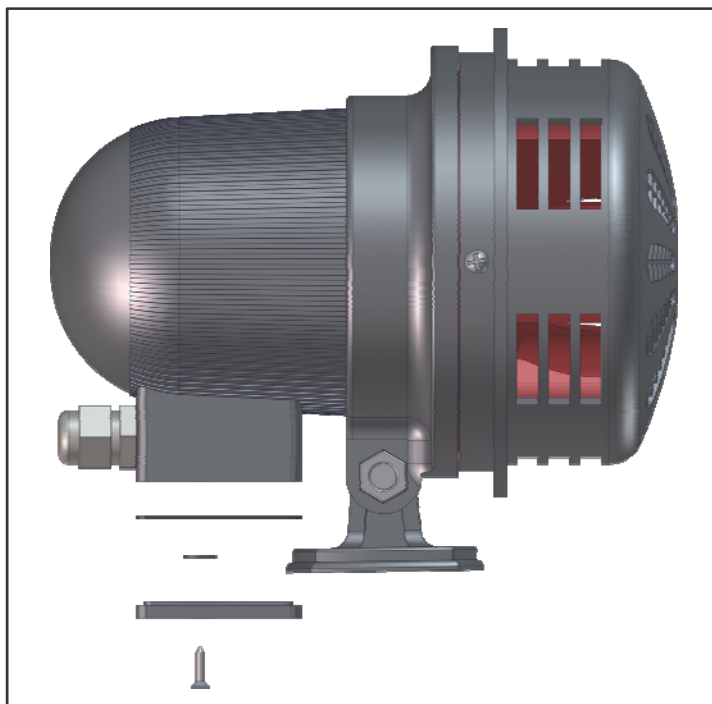
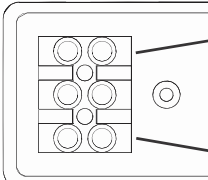

MDS-2/ UC/12	MDS-2/ UC/24	MDS-2/ UC/115/	MDS-2/ UC/230/
-ve (0V)	-ve (0V)	N	N
		Earth	Earth
+ve (12Vuc)	+ve (24Vuc)	P (115Vuc)	P (230Vuc)

Note:

This unit is rated for a duty-cycle of 5 minutes on - 10 minutes off.

The unit should ideally be mounted in a horizontal position. In environments where dirt or particles may fall onto the moving parts of the siren's impeller, it is recommended to mount the unit with the nose cone facing down.

For fitment of unit, mount in desired position using both mounting holes situated on the mounting foot.

Replace terminal cover prior to applying power to the unit.